

SERIE TRENTA

LAVORAZIONE MODERNA

MODERNE METALLGESTALTUNG

MODERN METAL MouldING



WOLFSGRUBER



innovative steel design







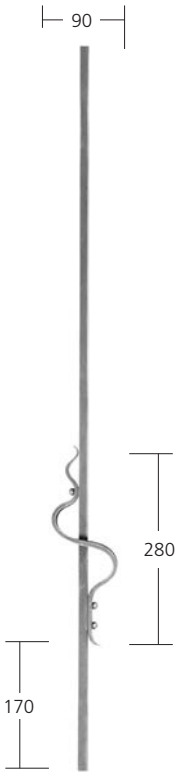

17090 Ø12 mm
1,38 kg



17092 Ø12 mm
1,20 kg



17094 Ø12 mm
1,1 kg



17096 Ø12 mm
1,4 kg



17098 Ø12 mm
1,5 kg



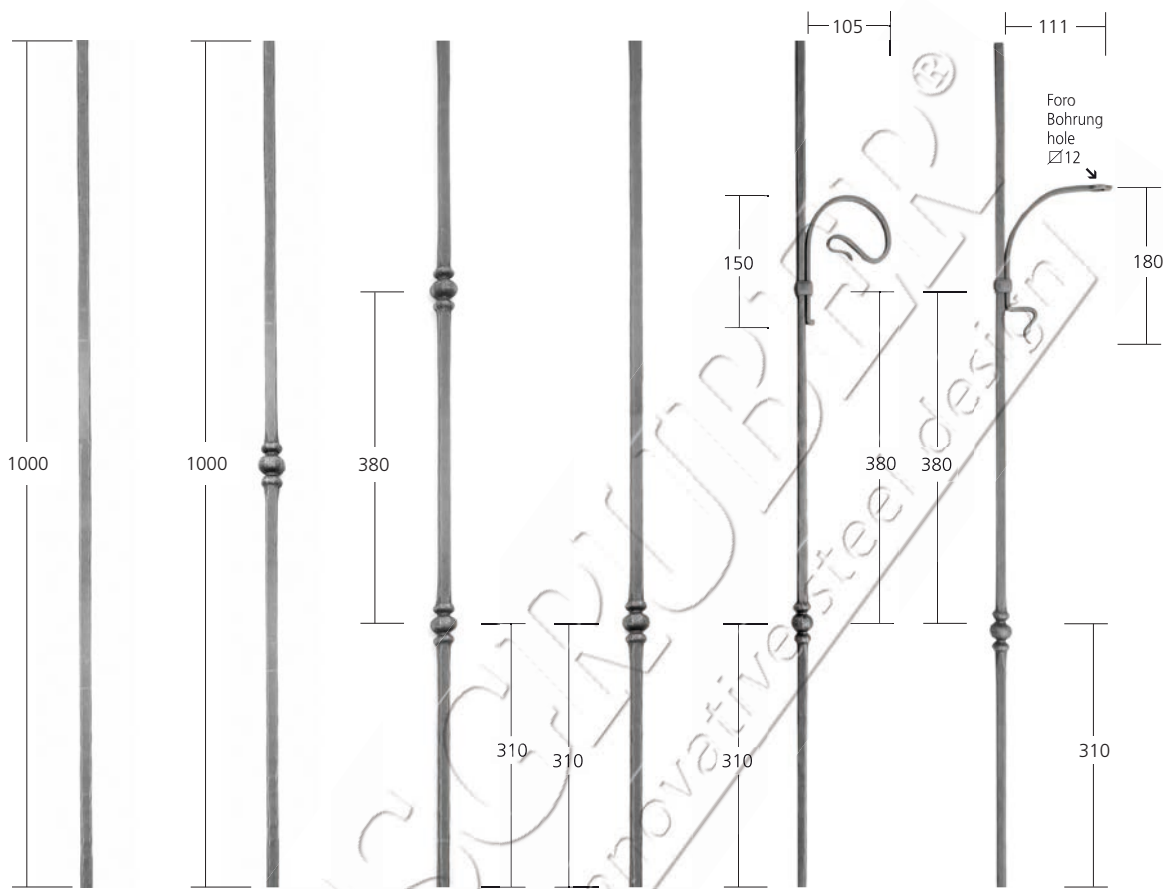

12464 ∅12 mm
1,00 kg

12465 ∅12 mm
1,10 kg

12466 ∅12 mm
1,18 kg

12467 ∅12 mm
1,10 kg

12468 ∅12 mm
1,28 kg

12469 ∅12 mm
1,25 kg



forgiato a mano · handgeschmiedet · hand forged

Trenta

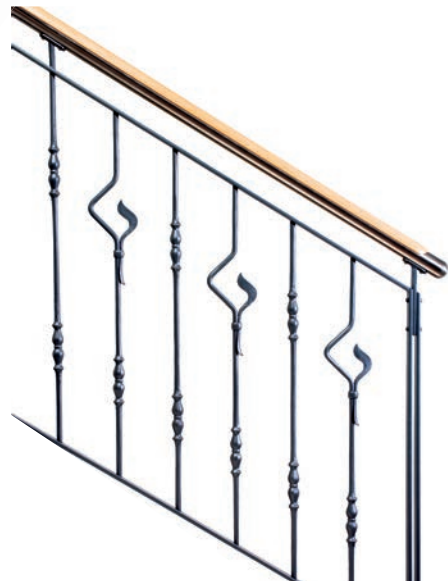
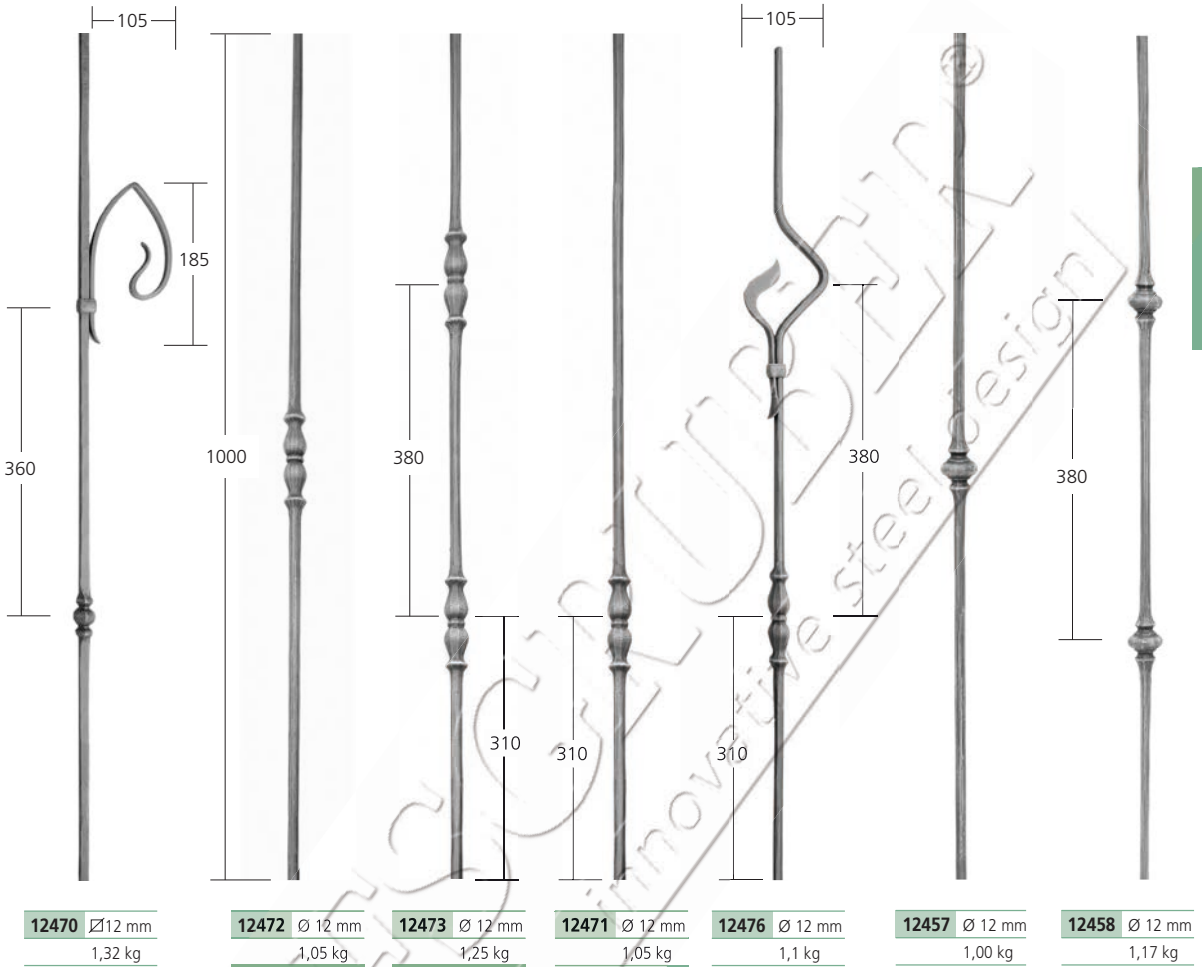

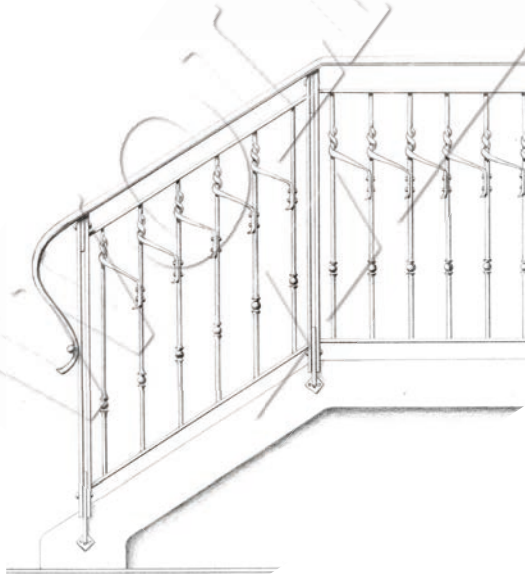
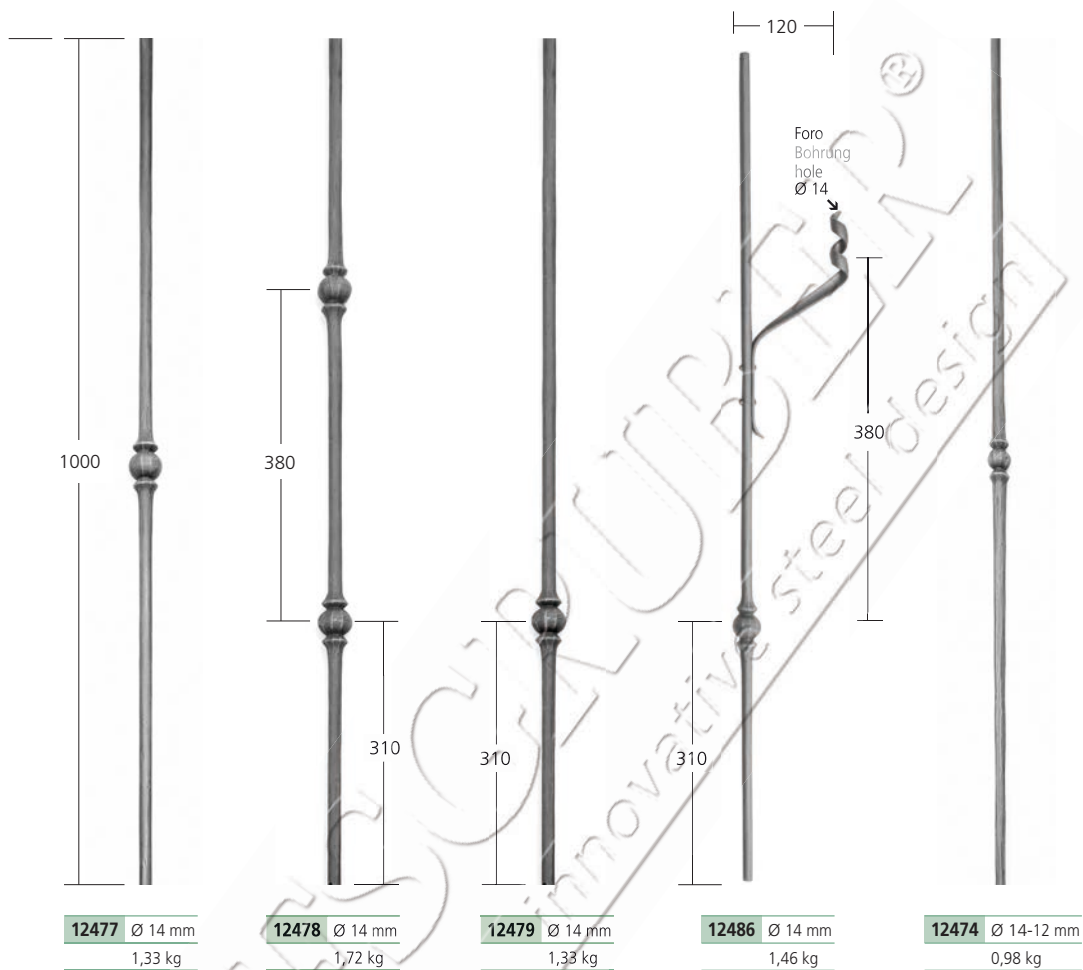

forgiato a mano · handgeschmiedet · hand forged

Trenta

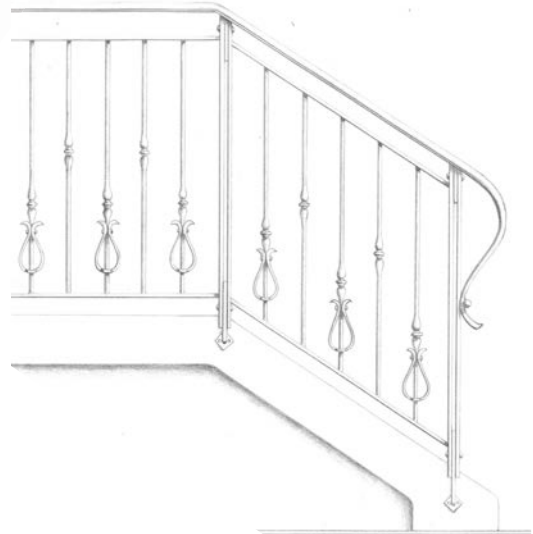
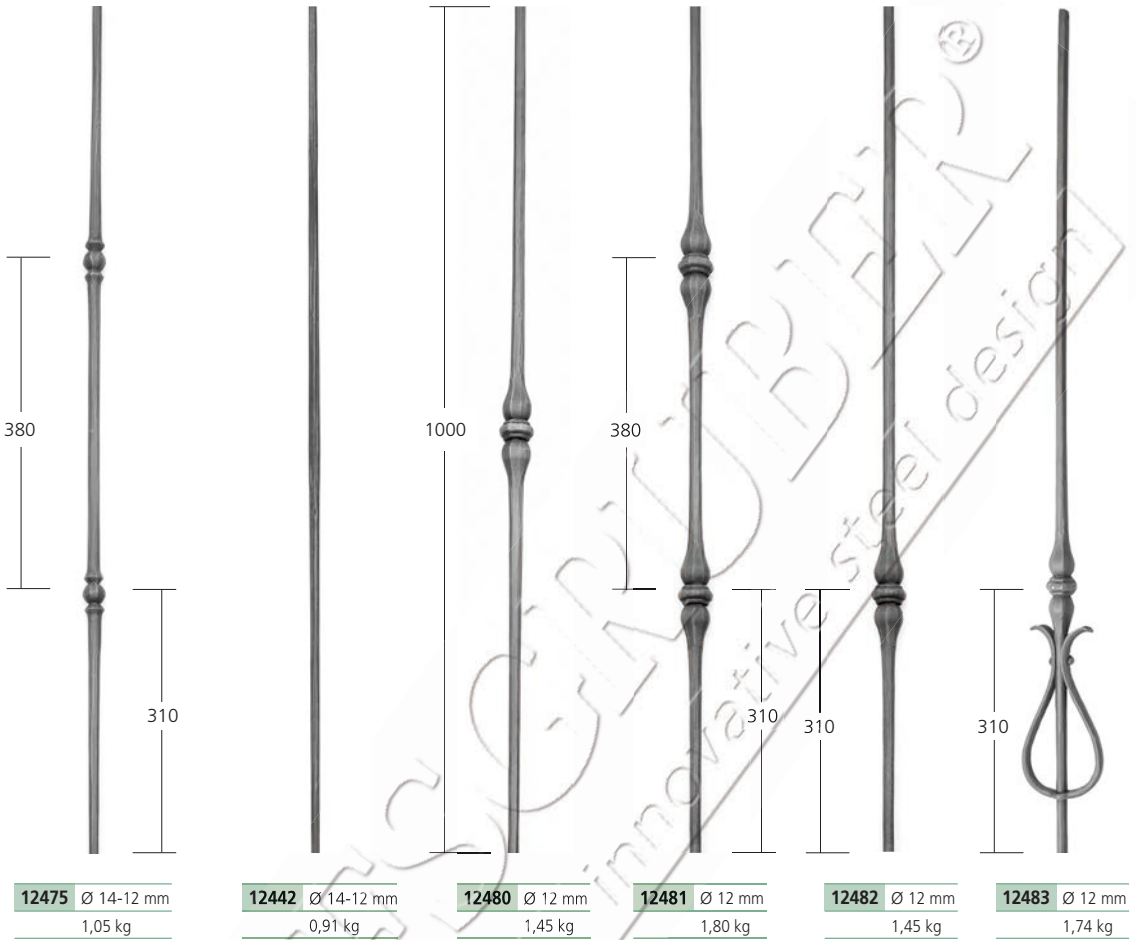

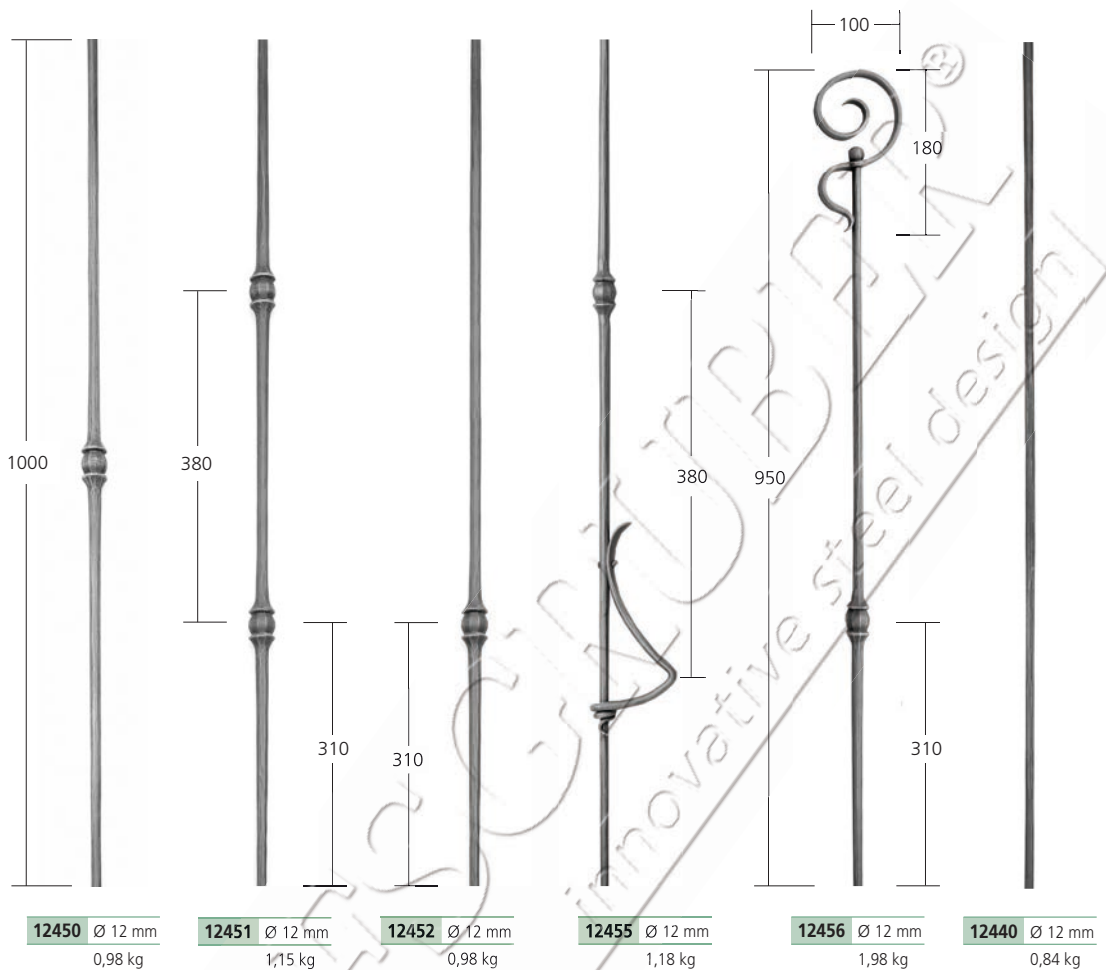



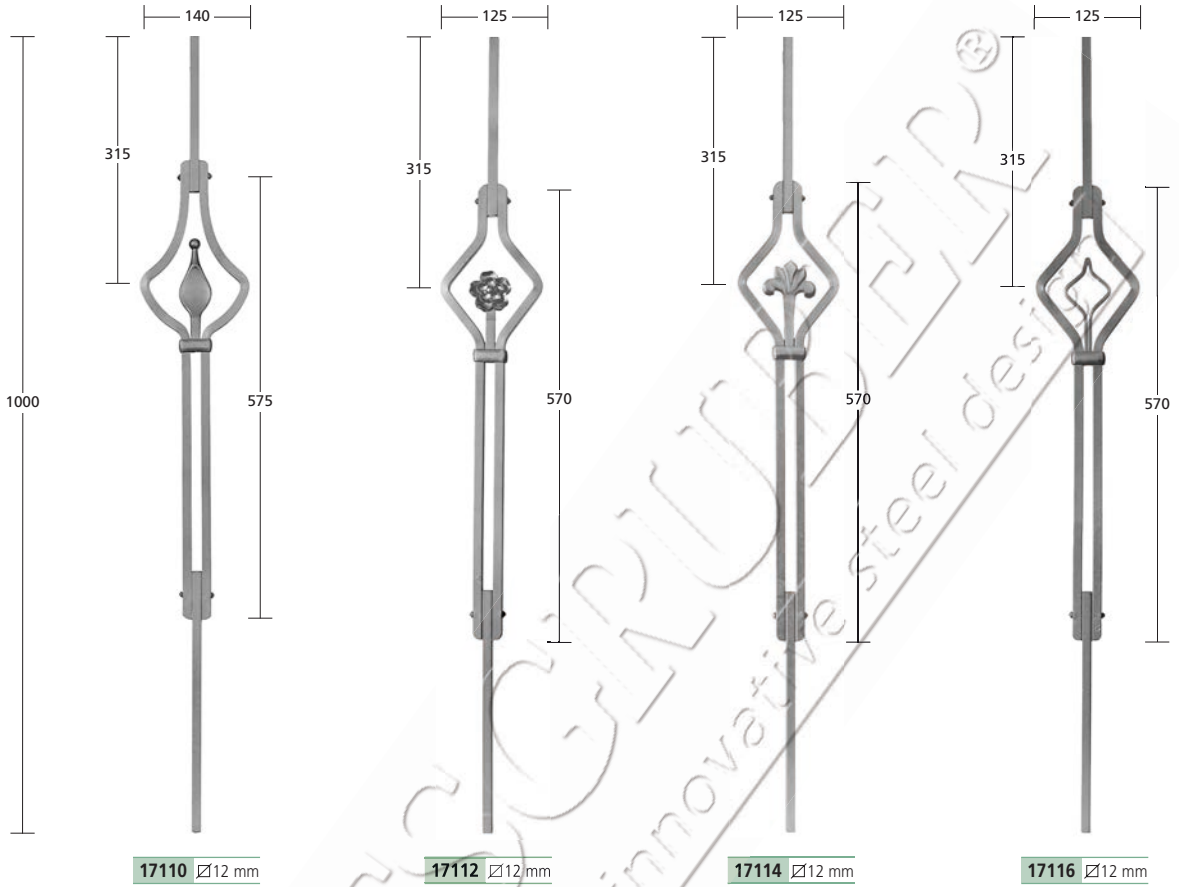

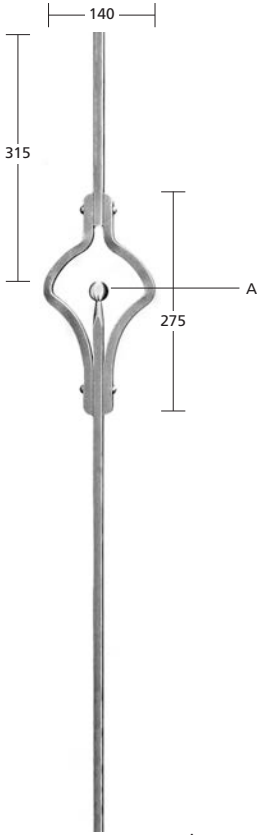

17117 \varnothing 12 mm Ferro - Stahl
17117-I \varnothing 12 mm Inox - Edelstahl

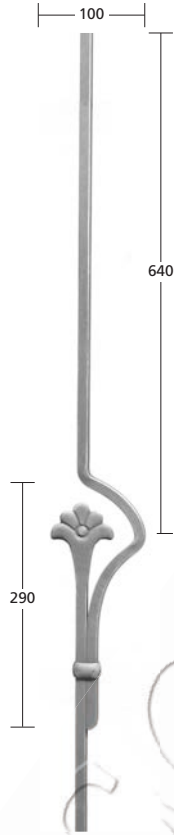

17119 \varnothing 12 mm



17120 \varnothing 12 mm

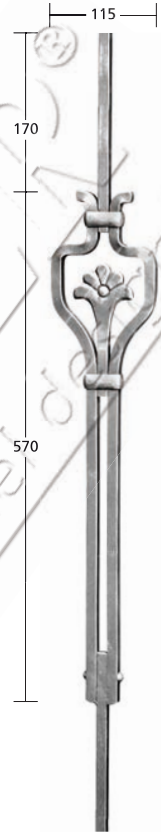

17121 \varnothing 12 mm



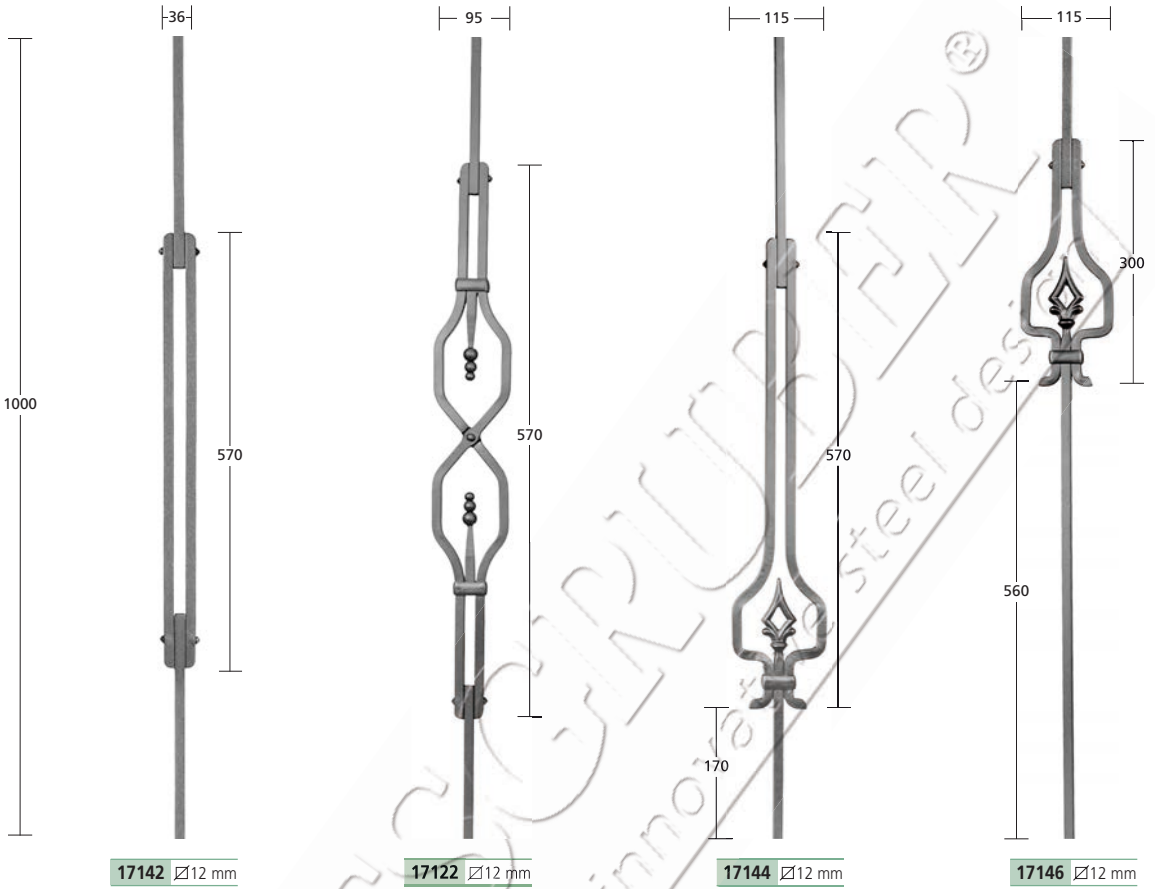

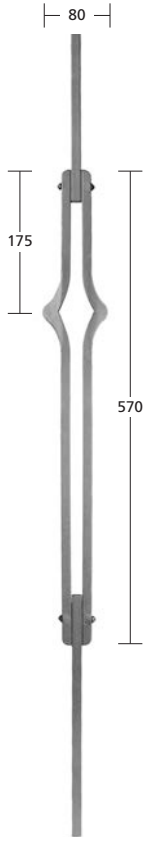

17140 \varnothing 12 mm

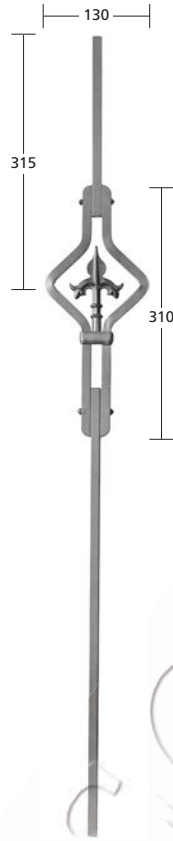

17118 \varnothing 12 mm



17128 \varnothing 12 mm

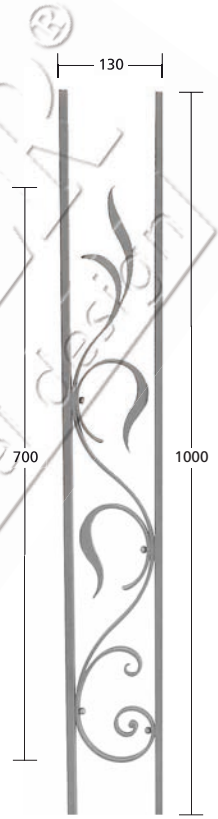

17131 \varnothing 12 mm





17150 Ø12 mm



17151 Ø12 mm



17154 Ø12 mm



17155 Ø12 mm



17156 Ø12 mm



17160 Ø12 mm



46049 H: 1000 mm Ø 12 mm
46050 H: 500 mm Ø 20 mm
46052 H: 1000 mm Ø 20 mm



46055 H: 500 mm
46057 H: 1000 mm



46038 H: 500 mm
46039 H: 1000 mm

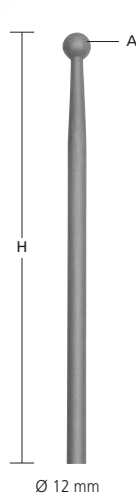

46034 H: 1000 mm Ø 12 mm
46035 H: 500 mm Ø 18 mm
46037 H: 1000 mm Ø 18 mm

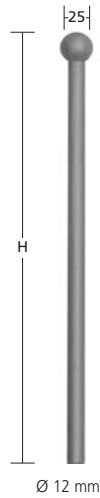

46060 H: 600 mm
46061 H: 1000 mm
46062 H: 1200 mm

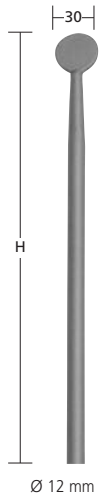

46040 H: 500 mm
46042 H: 1000 mm

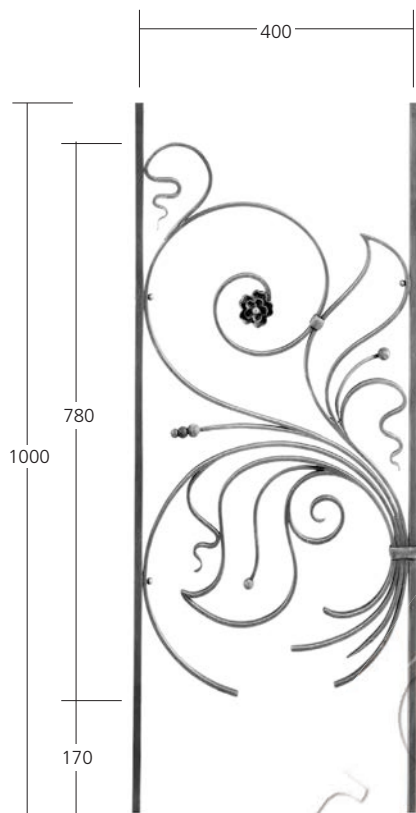

37005 Mat. 12x6 mm
5,72 kg

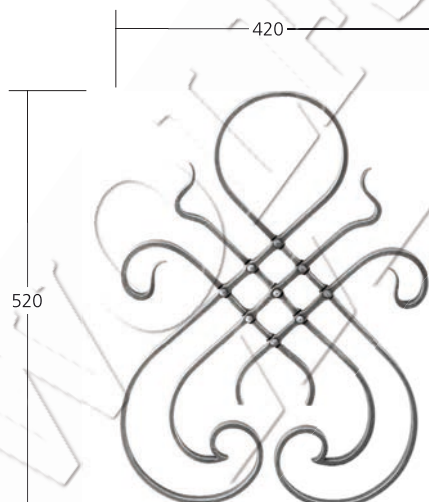

37008 Mat. 16x8 mm
4,0 kg



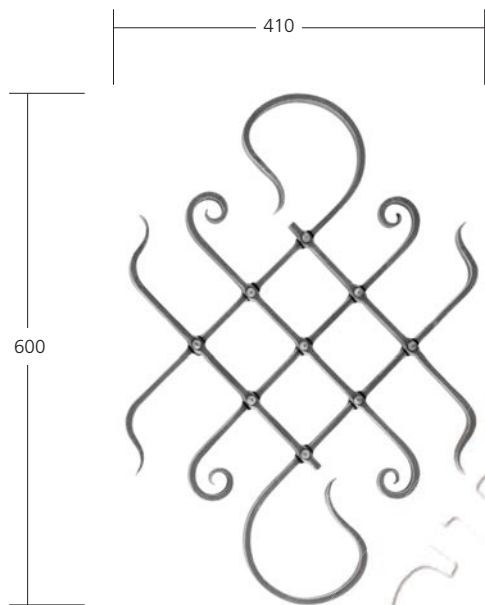

37010 Mat. 16x8 mm
3,22 kg

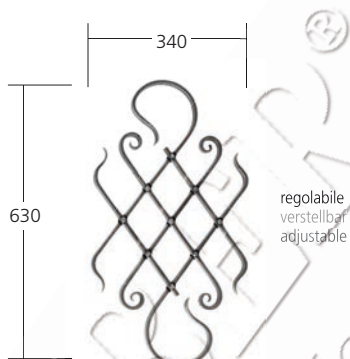

regolabile
verstellbar
adjustable

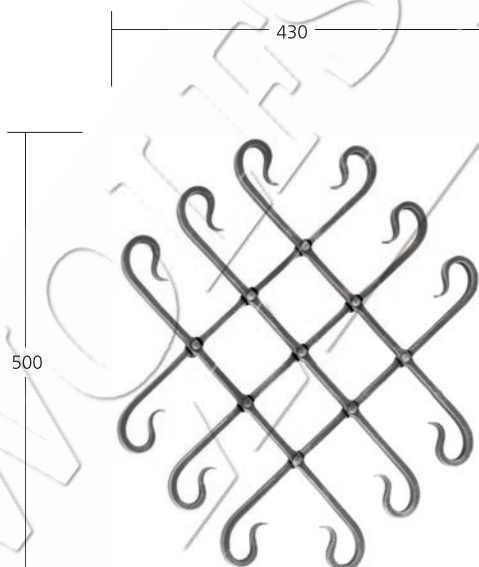

37012 Mat. 16x8 mm
3,34 kg

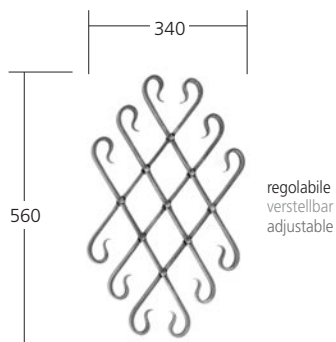

regolabile
verstellbar
adjustable

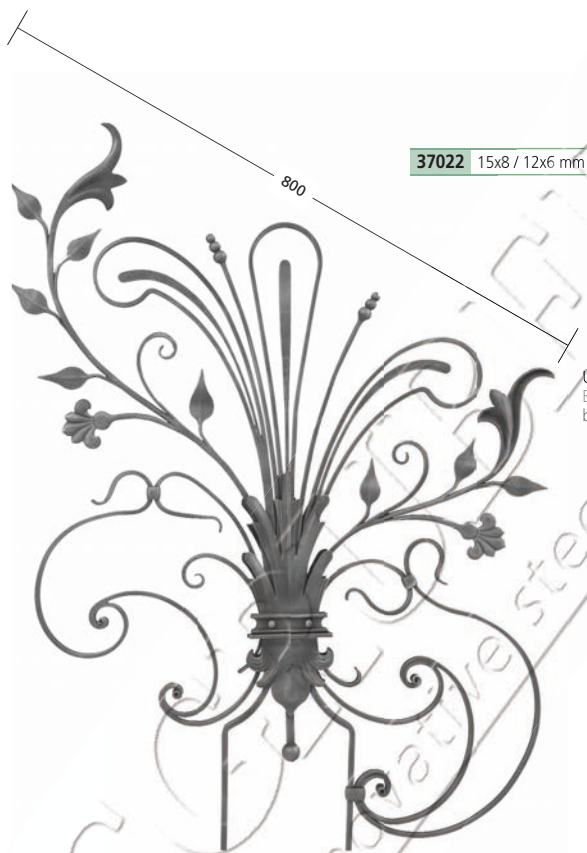

Usabile a due lati
Beidseitig verwendbar
both side usable

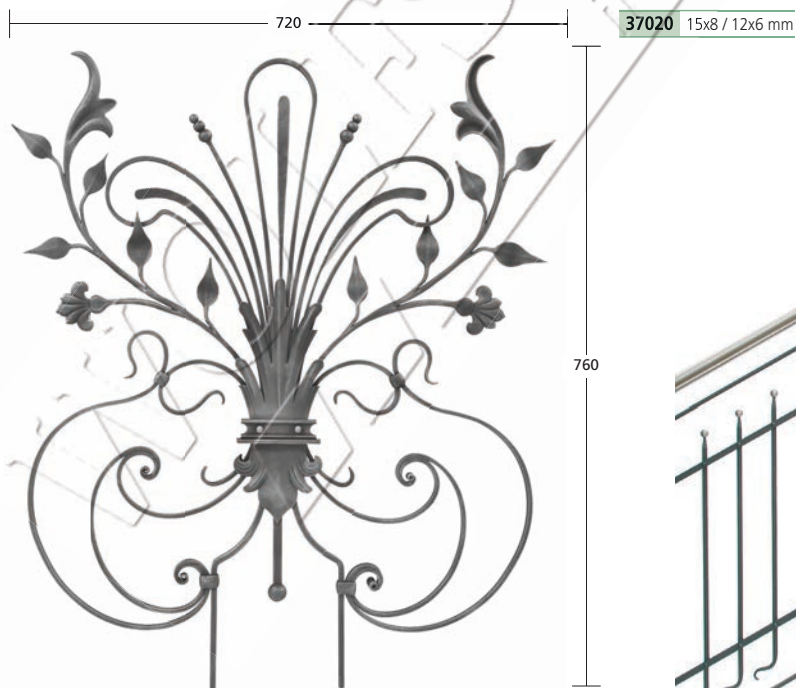

Linea
Trenta

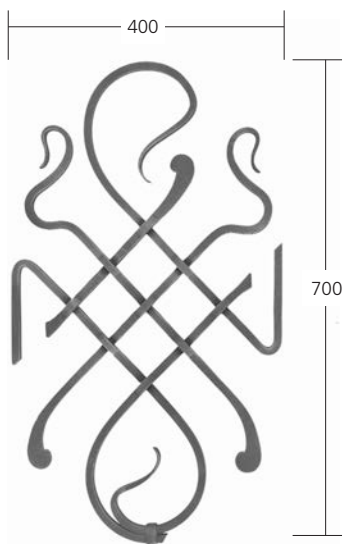

37030 $\varnothing 12$ mm

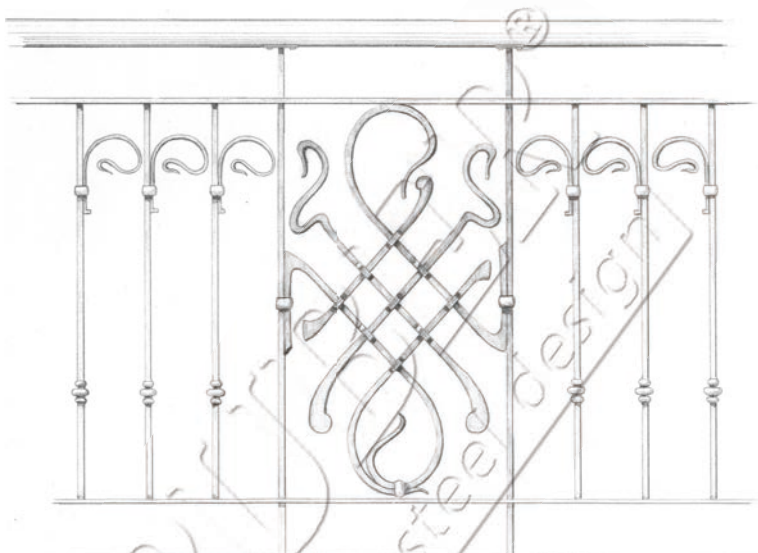

Usabile a due lati
Beidseitig verwendbar
both side usable

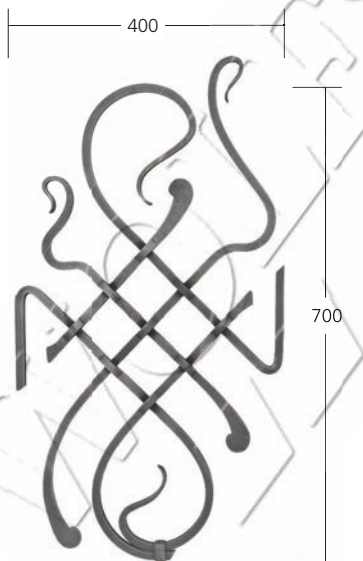

37032 $\varnothing 12$ mm

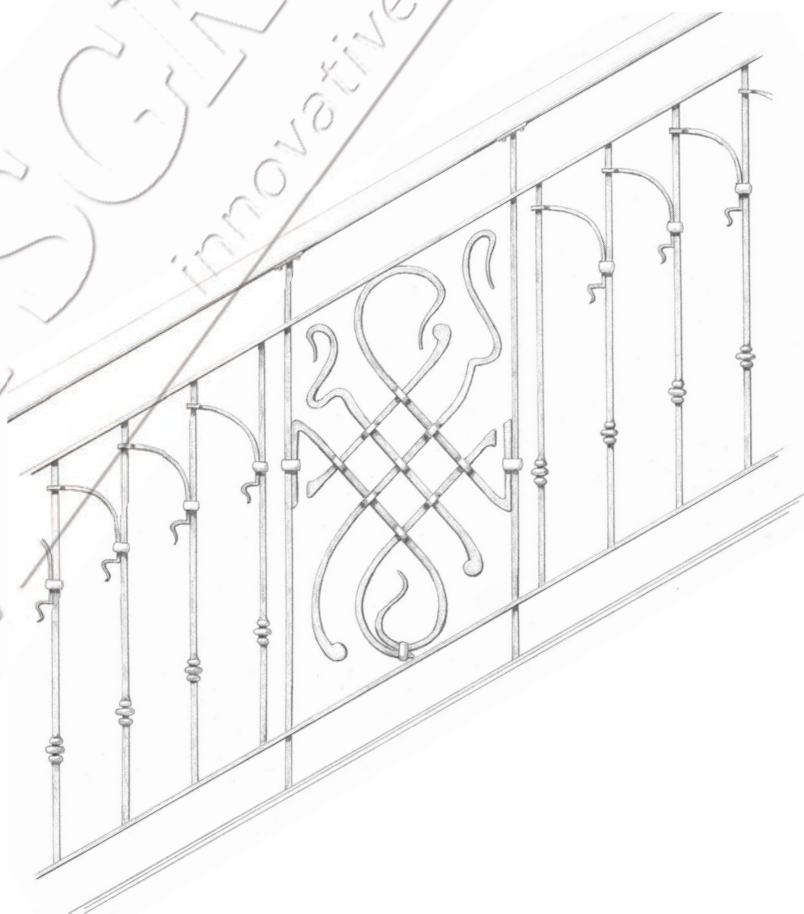

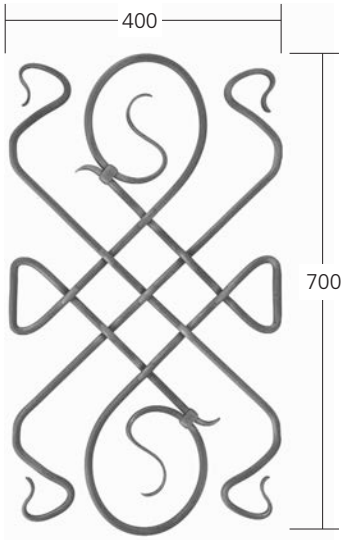

37050 Ø 12 mm

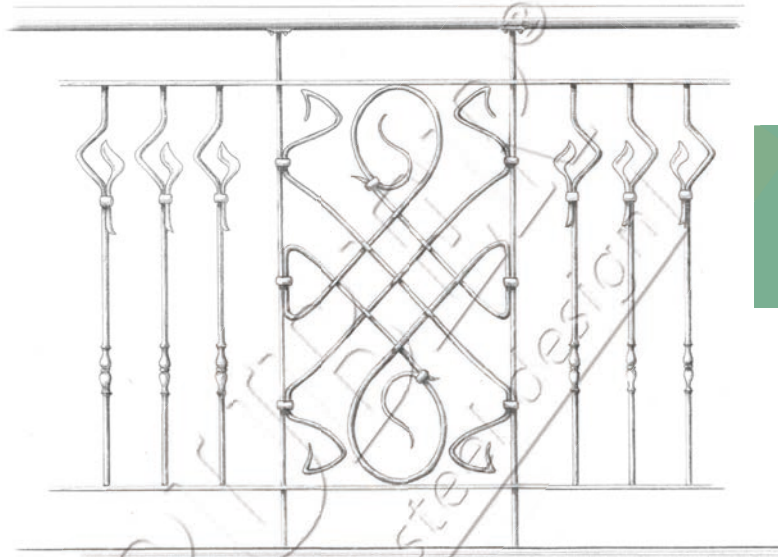

Usabile a due lati
Beidseitig verwendbar
both side usable

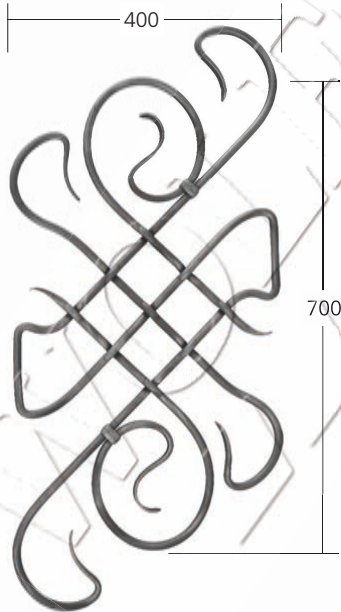

37052 Ø 12 mm

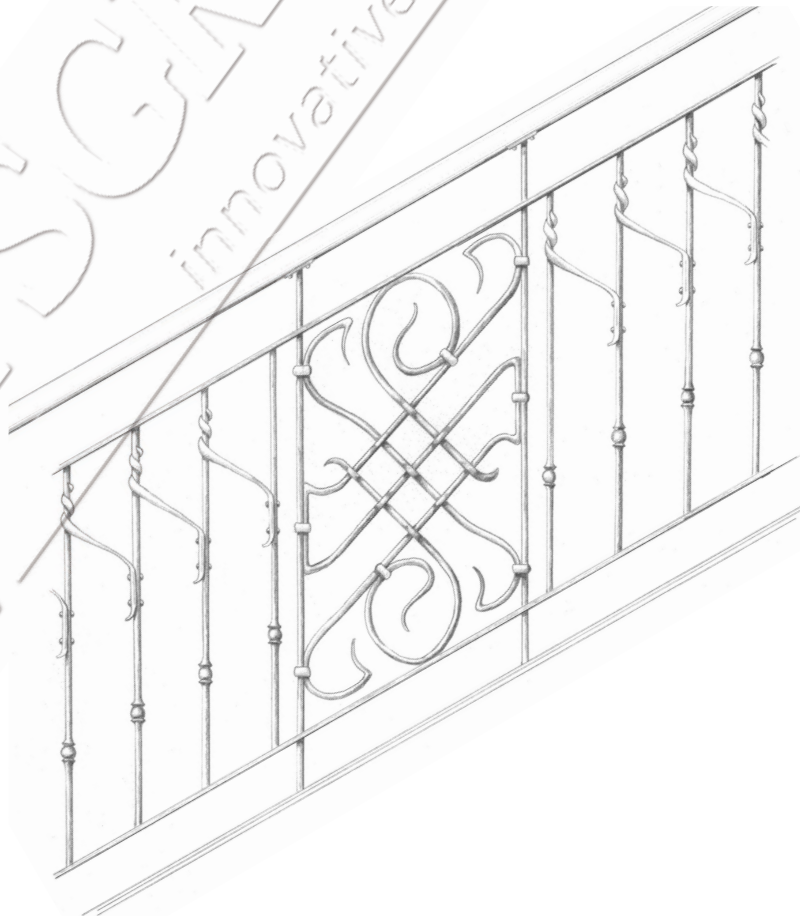

Trenta

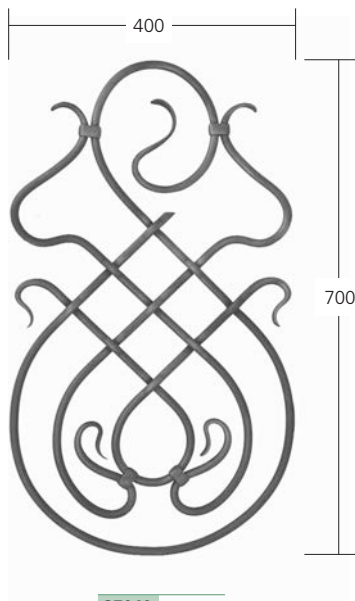

37040 Ø 12 mm

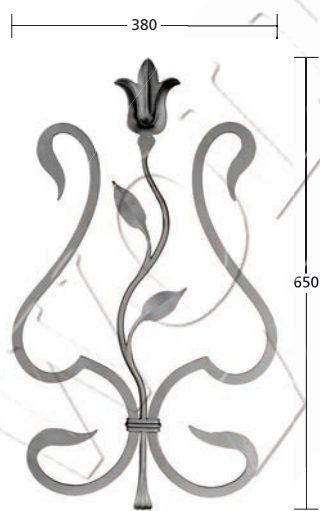
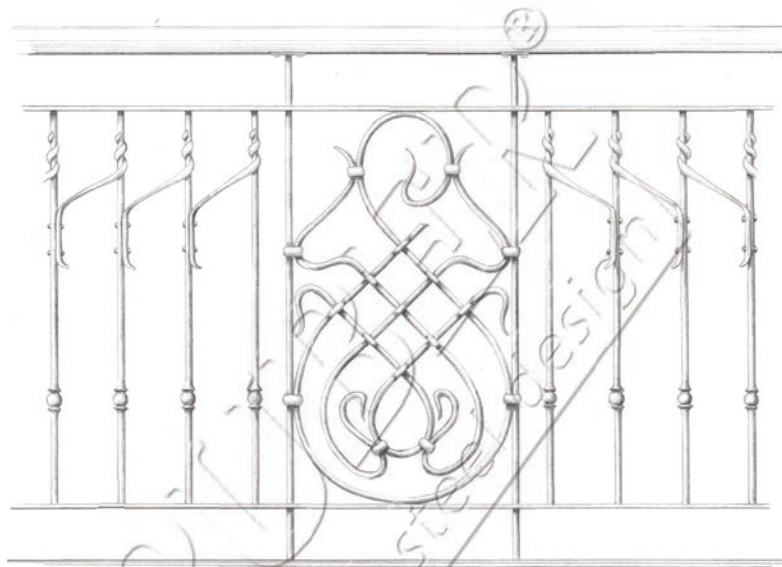

37110

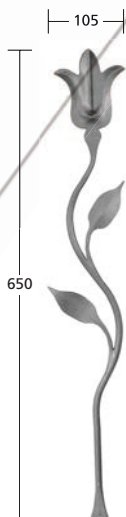

37114 Ø 10 mm



37115 12x6 mm



37116 12x6 mm



Trenta



37130 12x6 mm

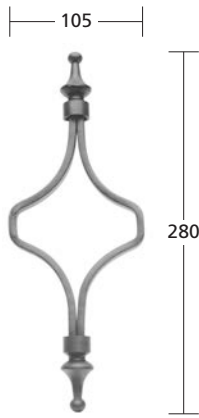

37132 12x6 mm

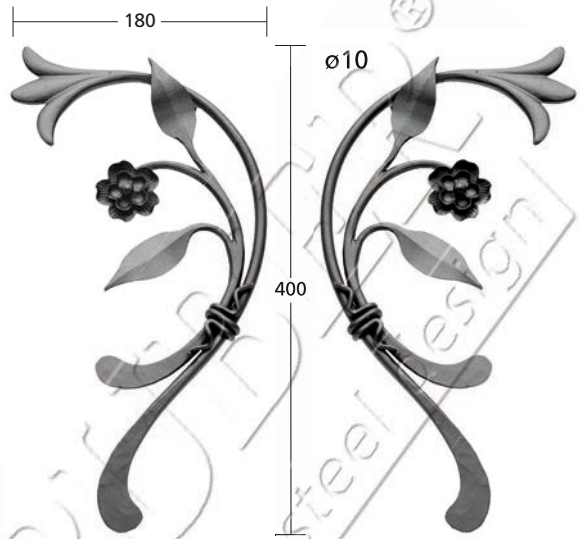

37140

37142



37120



12 x 12 x 6 Fascetta - Bund

37152 16x3 mm

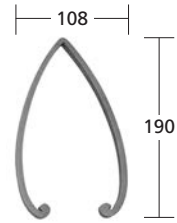

37150 12x6 mm



37125 12x6 mm